

File System

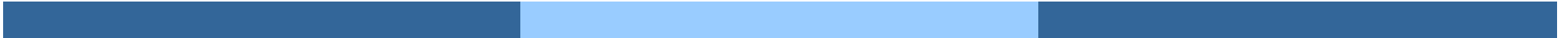

File Concept

- Contiguous logical address space

- Types:
 - Data
 - ▶ numeric
 - ▶ character
 - ▶ binary
 - Program

- Contents defined by file's creator
 - Many types
 - ▶ Consider **text file, source file, executable file**

File Attributes

- **Name** – only information kept in human-readable form
- **Identifier** – unique tag (number) identifies file within file system
- **Type** – needed for systems that support different types
- **Location** – pointer to file location on device
- **Size** – current file size
- **Protection** – controls who can do reading, writing, executing
- **Time, date, and user identification** – data for protection, security, and usage monitoring
- Information about files are kept in the directory structure, which is maintained on the disk
- Many variations, including extended file attributes such as file checksum
- Information kept in the directory structure

File info Window on Mac OS X



File Operations

- File is an **abstract data type**
- **Create**
- **Write** – at **write pointer** location
- **Read** – at **read pointer** location
- **Reposition within file** - **seek**
- **Delete**
- **Truncate**
- **$Open(F_i)$** – search the directory structure on disk for entry F_i , and move the content of entry to memory
- **$Close(F_i)$** – move the content of entry F_i in memory to directory structure on disk

Open Files

- Several pieces of data are needed to manage open files:
 - **Open-file table**: tracks open files
 - File pointer: pointer to last read/write location, per process that has the file open
 - **File-open count**: counter of number of times a file is open – to allow removal of data from open-file table when last processes closes it
 - Disk location of the file: cache of data access information
 - Access rights: per-process access mode information

Open File Locking

- Provided by some operating systems and file systems
 - Similar to reader-writer locks
 - **Shared lock** similar to reader lock – several processes can acquire concurrently
 - **Exclusive lock** similar to writer lock
- Mediates access to a file
- Mandatory or advisory:
 - **Mandatory** – access is denied depending on locks held and requested
 - **Advisory** – processes can find status of locks and decide what to do

File Locking Example – Java API

```
import java.io.*;
import java.nio.channels.*;
public class LockingExample {
    public static final boolean EXCLUSIVE = false;
    public static final boolean SHARED = true;
    public static void main(String arsg[]) throws IOException {
        FileLock sharedLock = null;
        FileLock exclusiveLock = null;
        try {
            RandomAccessFile raf = new RandomAccessFile("file.txt", "rw");
            // get the channel for the file
            FileChannel ch = raf.getChannel();
            // this locks the first half of the file - exclusive
            exclusiveLock = ch.lock(0, raf.length()/2, EXCLUSIVE);
            /** Now modify the data . . . */
            // release the lock
            exclusiveLock.release();
        }
    }
}
```

File Locking Example – Java API (Cont.)

```
        // this locks the second half of the file - shared
        sharedLock = ch.lock(raf.length()/2+1, raf.length(),
                               SHARED);

        /** Now read the data . . . */
        // release the lock
        sharedLock.release();
    } catch (java.io.IOException ioe) {
        System.err.println(ioe);
    }finally {
        if (exclusiveLock != null)
            exclusiveLock.release();
        if (sharedLock != null)
            sharedLock.release();
    }
}
}
```

File Types – Name, Extension

file type	usual extension	function
executable	exe, com, bin or none	ready-to-run machine- language program
object	obj, o	compiled, machine language, not linked
source code	c, cc, java, pas, asm, a	source code in various languages
batch	bat, sh	commands to the command interpreter
text	txt, doc	textual data, documents
word processor	wp, tex, rtf, doc	various word-processor formats
library	lib, a, so, dll	libraries of routines for programmers
print or view	ps, pdf, jpg	ASCII or binary file in a format for printing or viewing
archive	arc, zip, tar	related files grouped into one file, sometimes com- pressed, for archiving or storage
multimedia	mpeg, mov, rm, mp3, avi	binary file containing audio or A/V information

File Structure

- None - sequence of words, bytes
- Simple record structure
 - Lines
 - Fixed length
 - Variable length
- Complex Structures
 - Formatted document
 - Relocatable load file
- Can simulate last two with first method by inserting appropriate control characters
- Who decides:
 - Operating system
 - Program

Sequential-access File

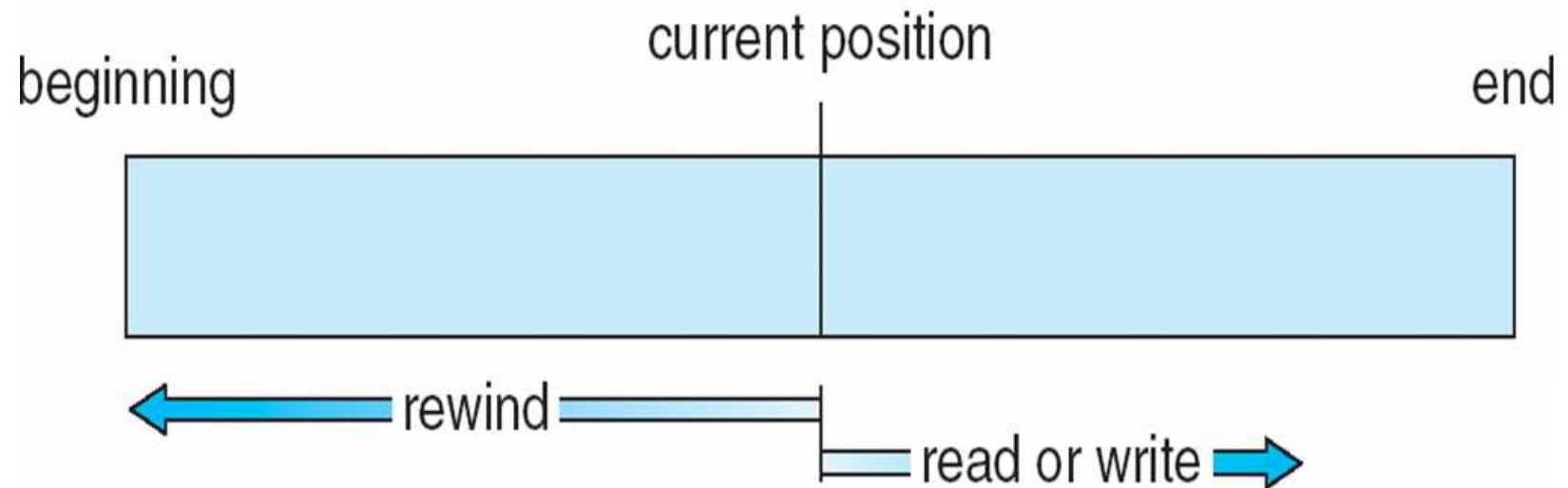

Access Methods

- **Sequential Access**

 - `read next`
 - `write next`
 - `reset`
 - no read after last write
(rewrite)

- **Direct Access** – file is fixed length **logical records**

 - `read n`
 - `write n`
 - `position to n`
 - `read next`
 - `write next`
 - `rewrite n`

n = relative block number

- Relative block numbers allow OS to decide where file should be placed
 - See **allocation problem** in Ch 11

Simulation of Sequential Access on Direct-access File

sequential access	implementation for direct access
<i>reset</i>	<i>cp = 0;</i>
<i>read next</i>	<i>read cp;</i> <i>cp = cp + 1;</i>
<i>write next</i>	<i>write cp;</i> <i>cp = cp + 1;</i>

Other Access Methods

- ❑ Can be built on top of base methods
- ❑ General involve creation of an **index** for the file
- ❑ Keep index in memory for fast determination of location of data to be operated on (consider UPC code plus record of data about that item)
- ❑ If too large, index (in memory) of the index (on disk)
- ❑ IBM indexed sequential-access method (ISAM)
 - ❑ Small master index, points to disk blocks of secondary index
 - ❑ File kept sorted on a defined key
 - ❑ All done by the OS
- ❑ VMS operating system provides index and relative files as another example (see next slide)

Example of Index and Relative Files

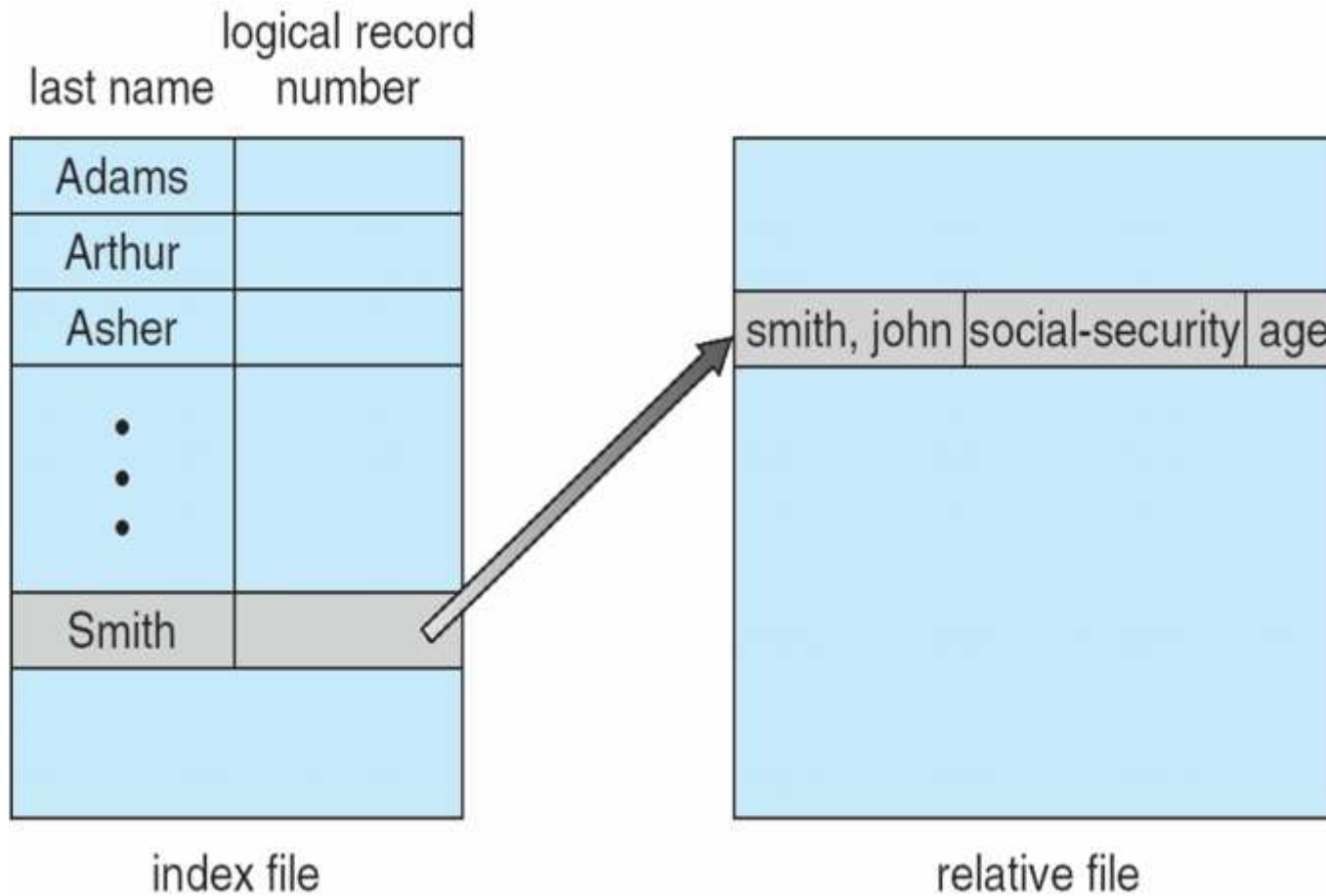

Directory Structure

- A collection of nodes containing information about all files

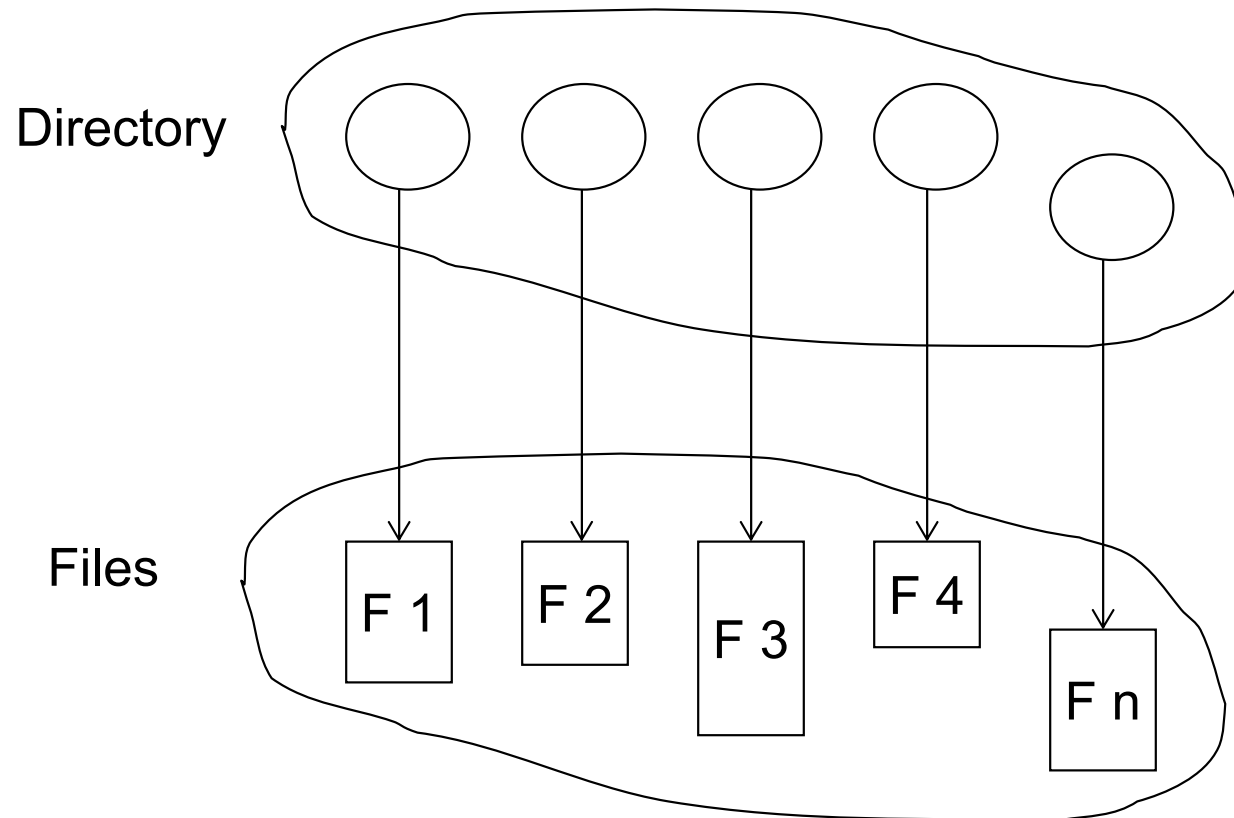

Both the directory structure and the files reside on disk

Disk Structure

- Disk can be subdivided into **partitions**
- Disks or partitions can be **RAID** protected against failure
- Disk or partition can be used **raw** – without a file system, or **formatted** with a file system
- Partitions also known as minidisks, slices
- Entity containing file system known as a **volume**
- Each volume containing file system also tracks that file system's info in **device directory** or **volume table of contents**
- As well as **general-purpose file systems** there are many **special-purpose file systems**, frequently all within the same operating system or computer

A Typical File-system Organization

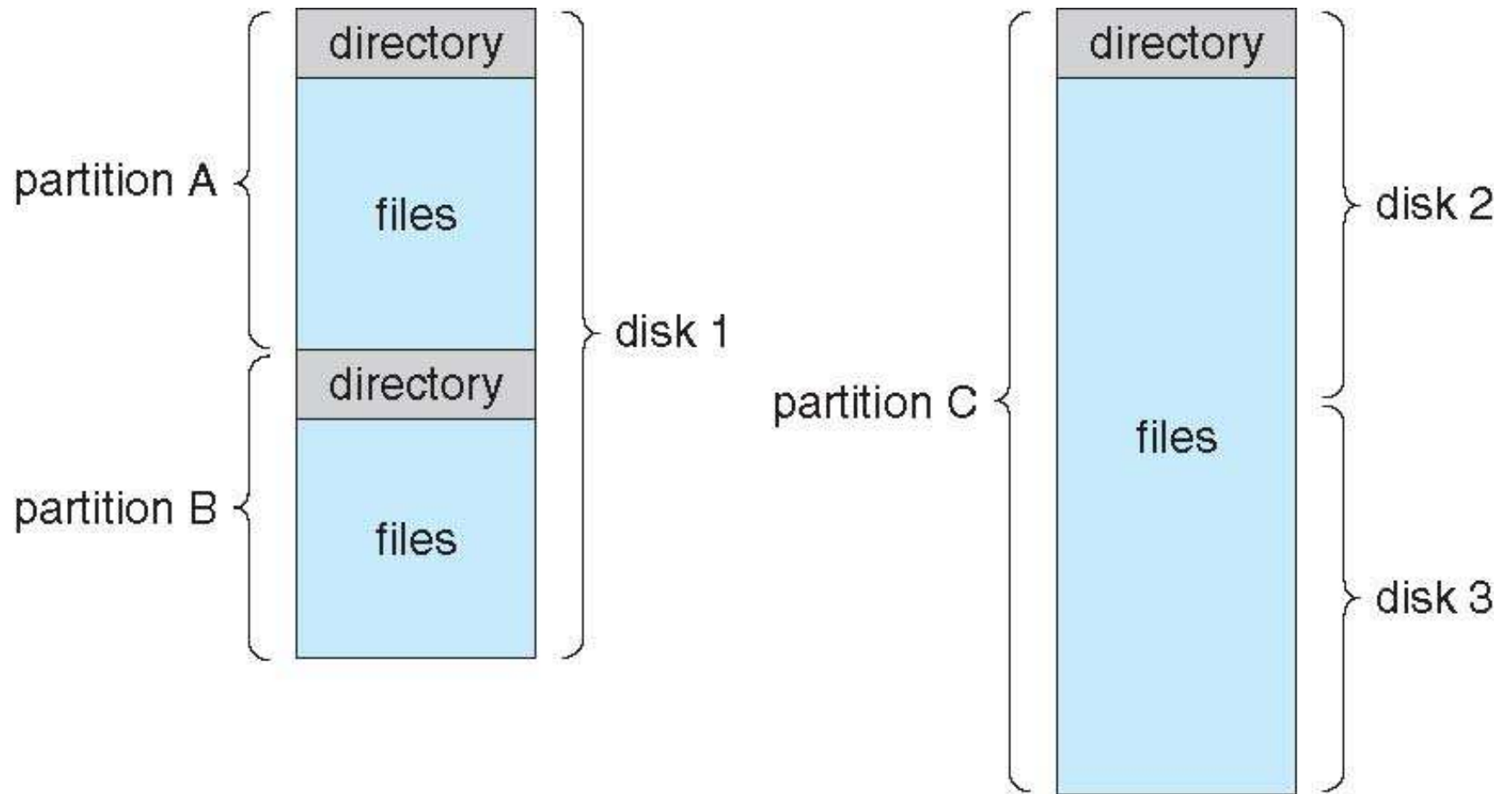

Types of File Systems

- We mostly talk of general-purpose file systems
- But systems frequently have many file systems, some general- and some special- purpose
- Consider Solaris has
 - tmpfs – memory-based volatile FS for fast, temporary I/O
 - objfs – interface into kernel memory to get kernel symbols for debugging
 - ctfs – contract file system for managing daemons
 - lofs – loopback file system allows one FS to be accessed in place of another
 - procfs – kernel interface to process structures
 - ufs, zfs – general purpose file systems

Operations Performed on Directory

- Search for a file
- Create a file
- Delete a file
- List a directory
- Rename a file
- Traverse the file system

Organize the Directory (Logically) to Obtain

- Efficiency – locating a file quickly

- Naming – convenient to users
 - Two users can have same name for different files
 - The same file can have several different names

- Grouping – logical grouping of files by properties, (e.g., all Java programs, all games, ...)

Single-Level Directory

- A single directory for all users

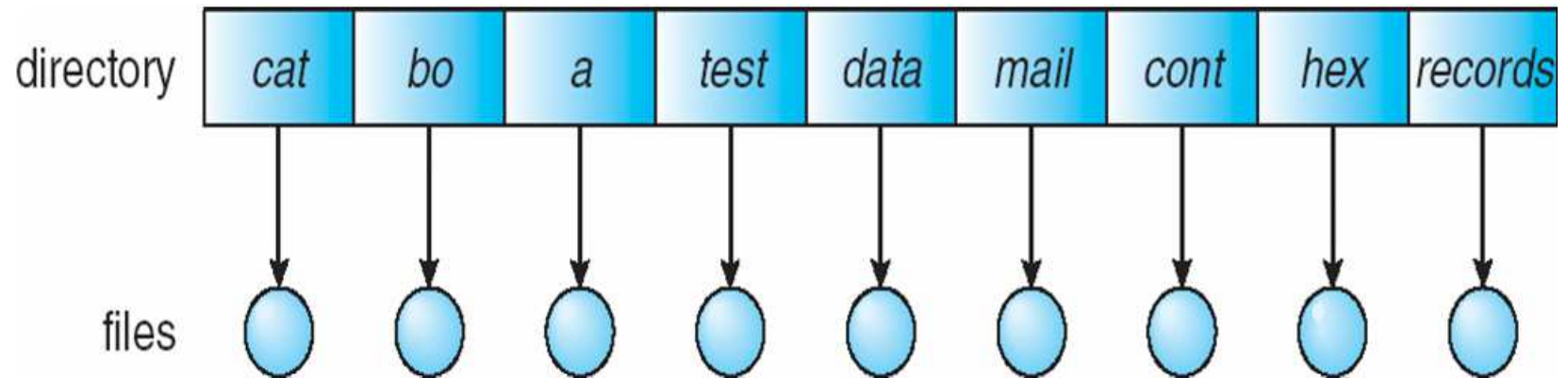

Naming problem

Grouping problem

Two-Level Directory

- Separate directory for each user

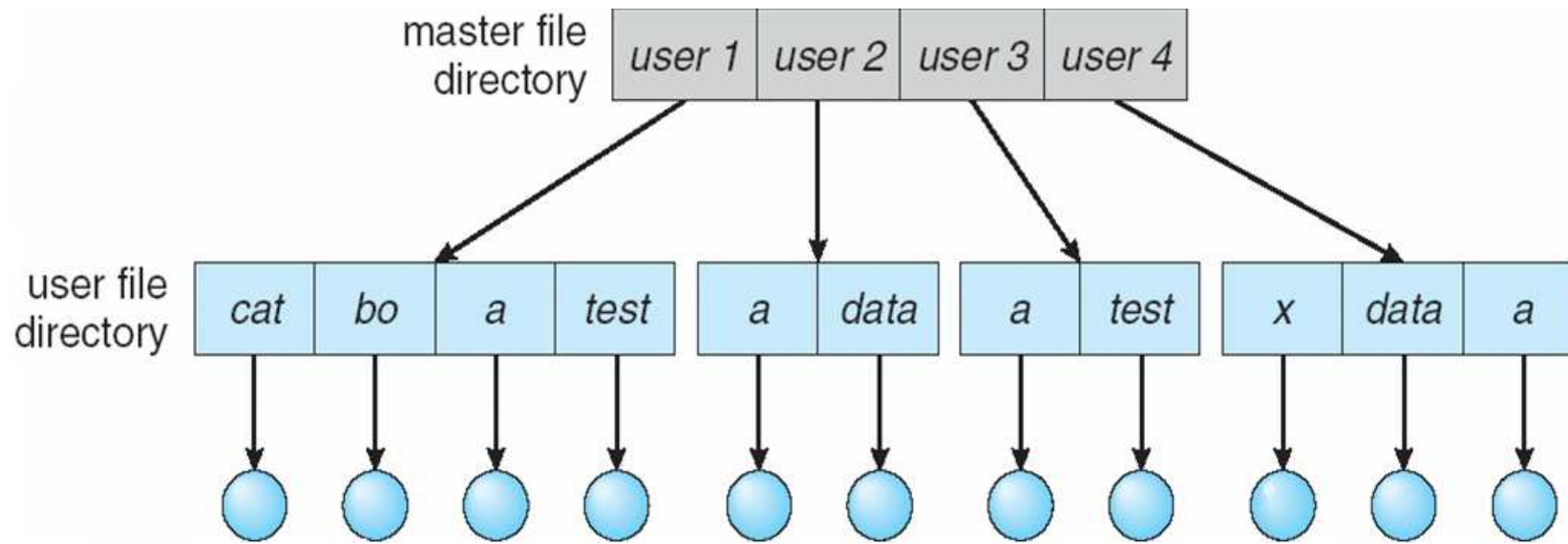

- Path name
- Can have the same file name for different user
- Efficient searching
- No grouping capability

Tree-Structured Directories

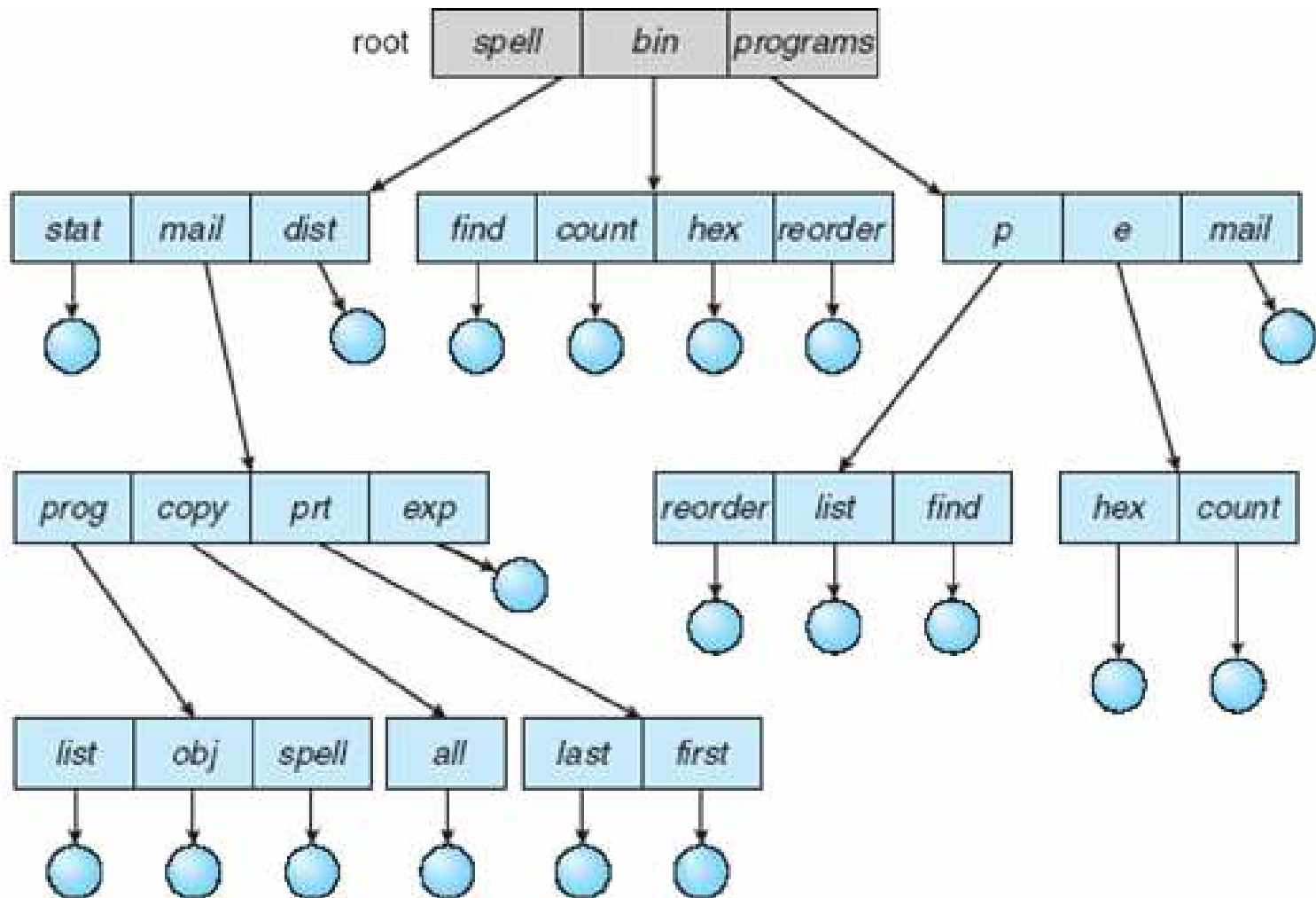

Tree-Structured Directories (Cont.)

- Efficient searching
- Grouping Capability
- Current directory (working directory)
 - `cd /spell/mail/prog`
 - `type list`

Tree-Structured Directories (Cont)

- **Absolute** or **relative** path name
- Creating a new file is done in current directory
- Delete a file

```
rm <file-name>
```

- Creating a new subdirectory is done in current directory

```
mkdir <dir-name>
```

Example: if in current directory `/mail`

```
mkdir count
```

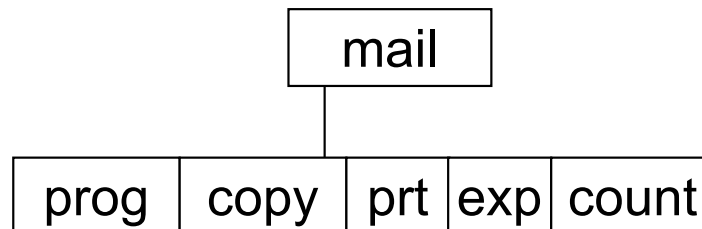

Deleting “mail” \Rightarrow deleting the entire subtree rooted by “mail”

Acyclic-Graph Directories

- Have shared subdirectories and files

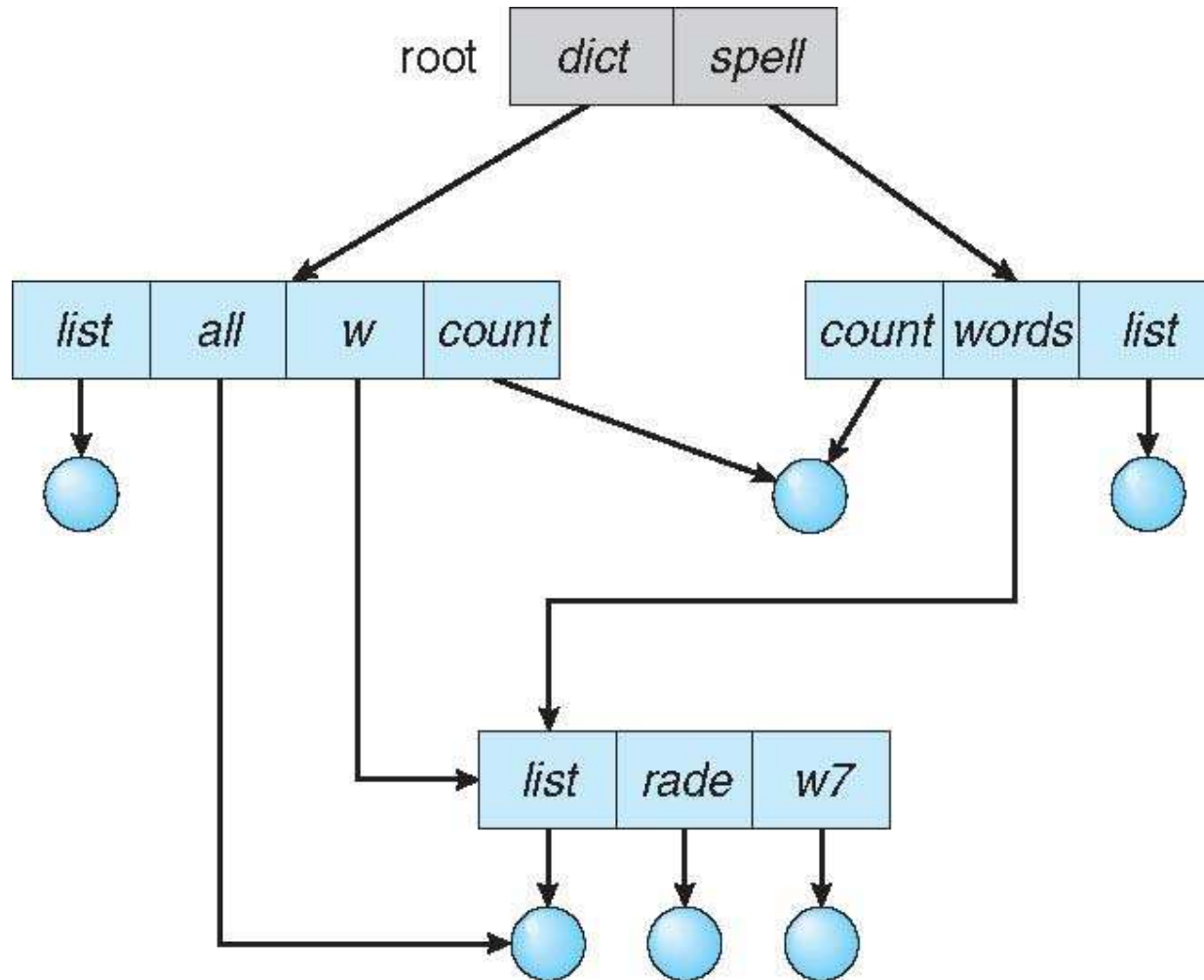

Acyclic-Graph Directories (Cont.)

- Two different names (aliasing)
- If *dict* deletes *list* \Rightarrow dangling pointer

Solutions:

- Backpointers, so we can delete all pointers
Variable size records a problem
 - Backpointers using a daisy chain organization
 - Entry-hold-count solution
-
- New directory entry type
 - **Link** – another name (pointer) to an existing file
 - **Resolve the link** – follow pointer to locate the file

General Graph Directory

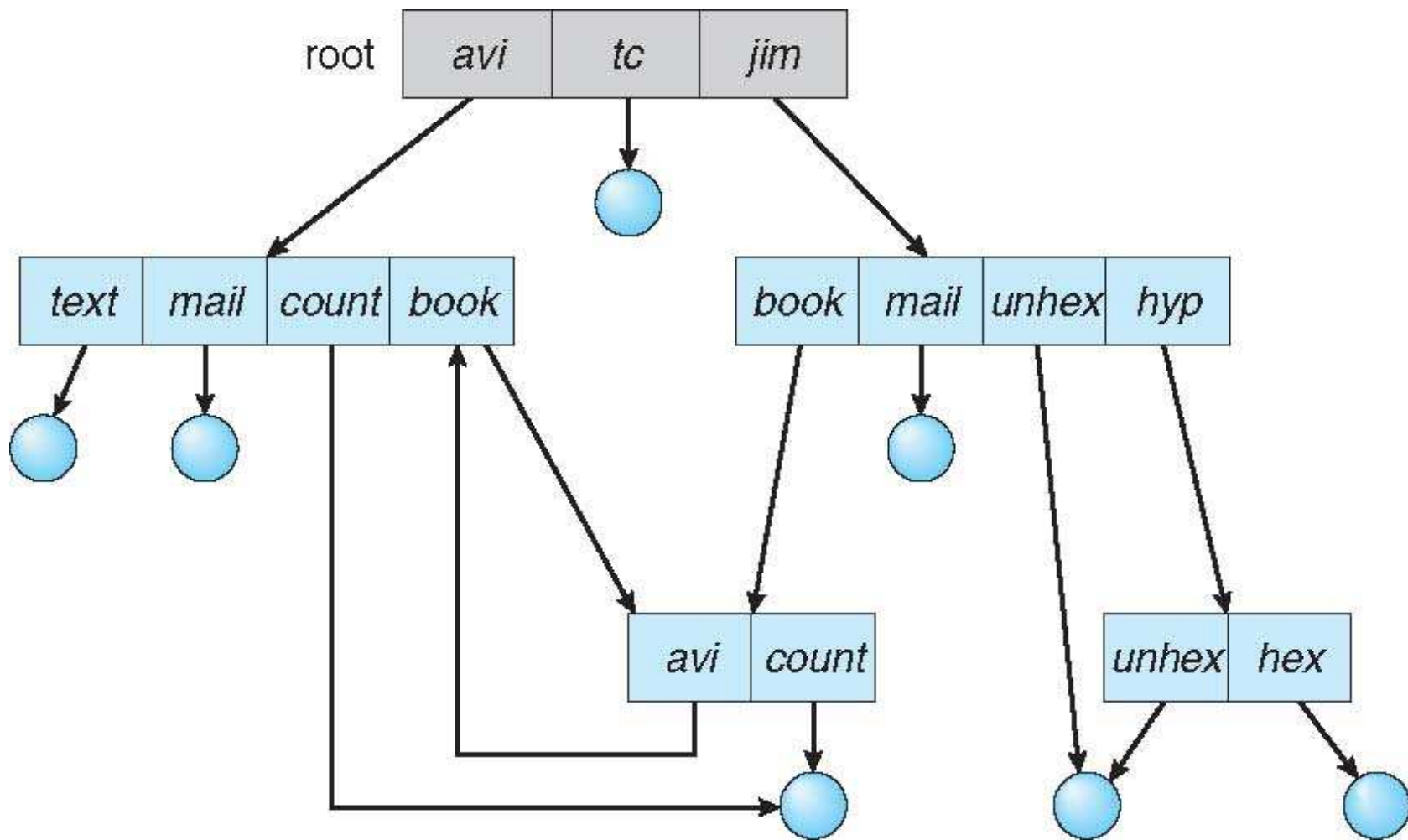

General Graph Directory (Cont.)

- How do we guarantee no cycles?
 - Allow only links to file not subdirectories
 - **Garbage collection**
 - Every time a new link is added use a cycle detection algorithm to determine whether it is OK

File System Mounting

- A file system must be **mounted** before it can be accessed
- An unmounted file system (i.e., Fig. 10-11(b)) is mounted at a **mount point**

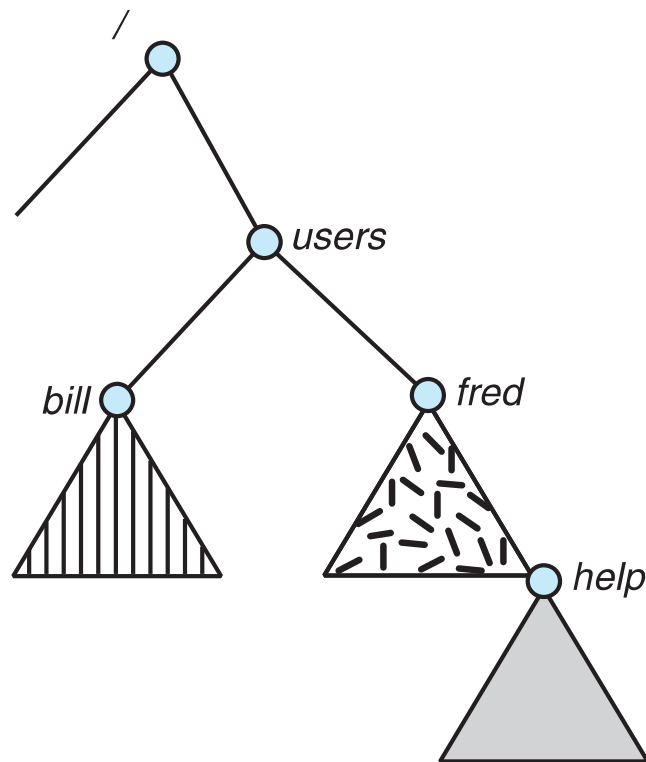

(a)

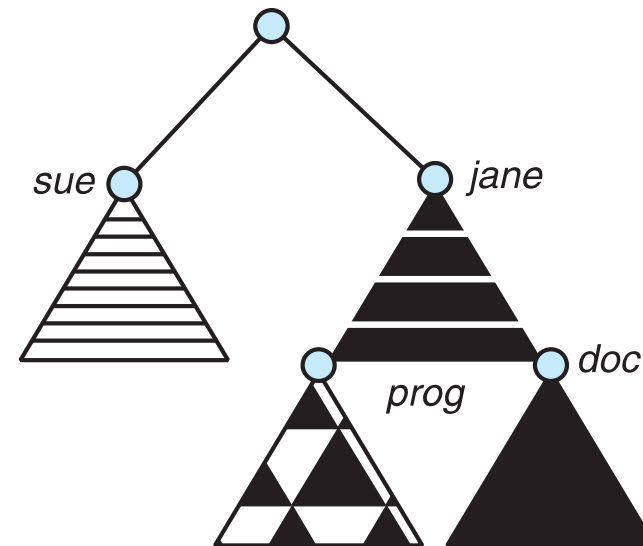

(b)

Mount Point

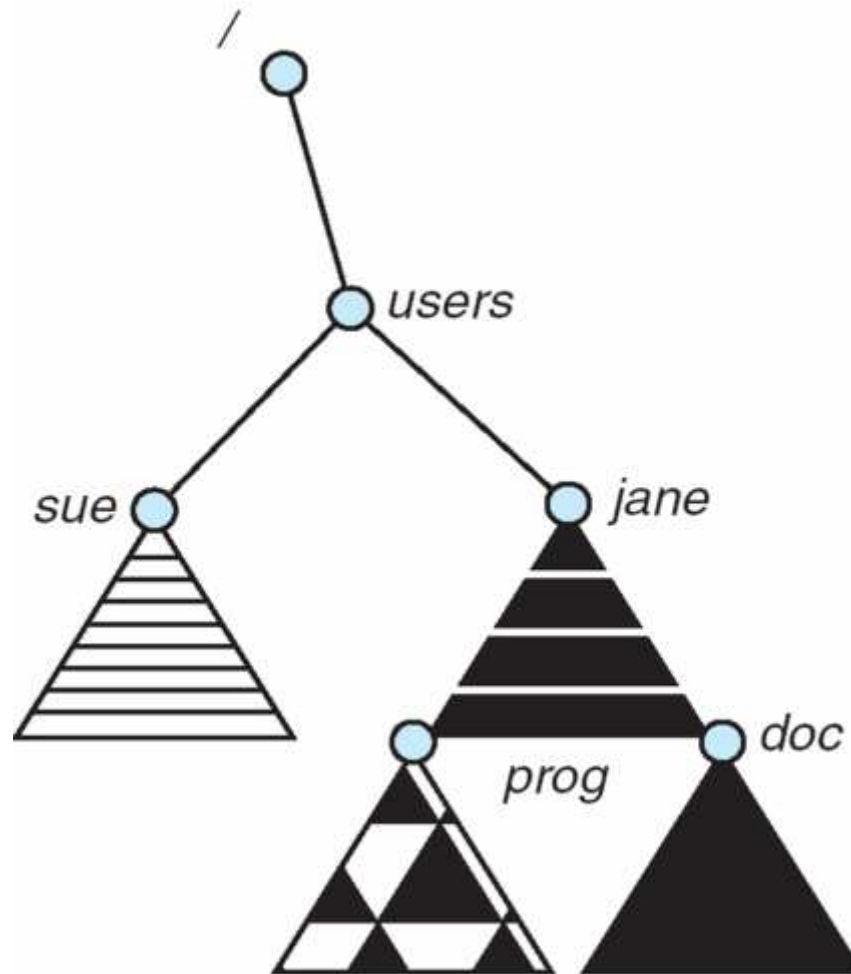

File Sharing

- Sharing of files on multi-user systems is desirable
- Sharing may be done through a **protection** scheme
- On distributed systems, files may be shared across a network
- Network File System (NFS) is a common distributed file-sharing method
- If multi-user system
 - **User IDs** identify users, allowing permissions and protections to be per-user
 - **Group IDs** allow users to be in groups, permitting group access rights
 - Owner of a file / directory
 - Group of a file / directory

File Sharing – Remote File Systems

- Uses networking to allow file system access between systems
 - Manually via programs like FTP
 - Automatically, seamlessly using **distributed file systems**
 - Semi automatically via the **world wide web**
- **Client-server** model allows clients to mount remote file systems from servers
 - Server can serve multiple clients
 - Client and user-on-client identification is insecure or complicated
 - **NFS** is standard UNIX client-server file sharing protocol
 - **CIFS** is standard Windows protocol
 - Standard operating system file calls are translated into remote calls
- Distributed Information Systems (**distributed naming services**) such as LDAP, DNS, NIS, Active Directory implement unified access to information needed for remote computing

File Sharing – Failure Modes

- All file systems have failure modes
 - For example corruption of directory structures or other non-user data, called **metadata**
- Remote file systems add new failure modes, due to network failure, server failure
- Recovery from failure can involve **state information** about status of each remote request
- **Stateless** protocols such as NFS v3 include all information in each request, allowing easy recovery but less security

File Sharing – Consistency Semantics

- Specify how multiple users are to access a shared file simultaneously
 - Similar to Ch 6 process synchronization algorithms
 - ▶ Tend to be less complex due to disk I/O and network latency (for remote file systems)
 - Andrew File System (AFS) implemented complex remote file sharing semantics
 - Unix file system (UFS) implements:
 - ▶ Writes to an open file visible immediately to other users of the same open file
 - ▶ Sharing file pointer to allow multiple users to read and write concurrently
 - AFS has session semantics
 - ▶ Writes only visible to sessions starting after the file is closed

Protection

- File owner/creator should be able to control:
 - what can be done
 - by whom
- Types of access
 - **Read**
 - **Write**
 - **Execute**
 - **Append**
 - **Delete**
 - **List**

Windows 7 Access-Control List Management

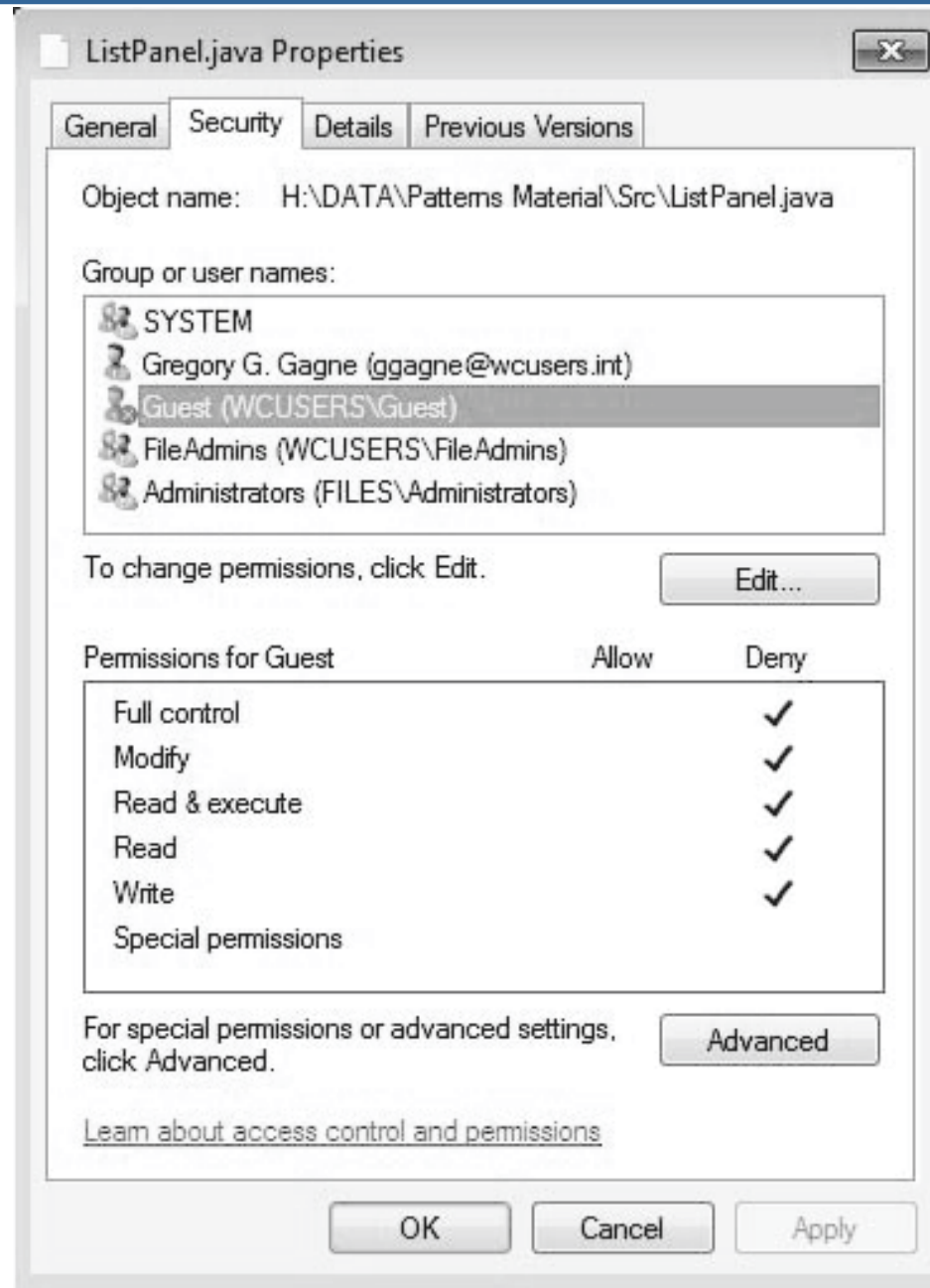

A Sample UNIX Directory Listing

```
-rw-rw-r--  1 pbg  staff  31200  Sep 3 08:30  intro.ps
drwx-----  5 pbg  staff    512  Jul 8 09:33  private/
drwxrwxr-x  2 pbg  staff    512  Jul 8 09:35  doc/
drwxrwx---  2 pbg  student  512  Aug 3 14:13  student-proj/
-rw-r--r--  1 pbg  staff   9423  Feb 24 2003  program.c
-rwxr-xr-x  1 pbg  staff  20471  Feb 24 2003  program
drwx--x--x  4 pbg  faculty   512  Jul 31 10:31  lib/
drwx-----  3 pbg  staff   1024  Aug 29 06:52  mail/
drwxrwxrwx  3 pbg  staff    512  Jul 8 09:35  test/
```